

Summary

April 28, 2026

Contents

0.1	Loaded Graphs	2
0.1.1	Xanthine	2
0.1.2	Caffeine	2
0.2	Loaded Rules	3
0.2.1	$r_{\{0\}}$	3
0.2.2	$r_{\{1\}}$	4
0.2.3	DG Hyper, dg_0	6
0.3	Product Graphs	6
0.3.1	Xanthine	6
0.3.2	Caffeine	7
0.3.3	$p_{\{0,0\}}$	8
0.3.4	$p_{\{0,1\}}$	8
0.3.5	$p_{\{0,2\}}$	9
0.3.6	$p_{\{0,3\}}$	9
0.3.7	$p_{\{0,4\}}$	10
0.3.8	$p_{\{0,5\}}$	11
0.4	Hyperflow Solutions, id 0	11

0.1 Loaded Graphs

0.1.1 Xanthine

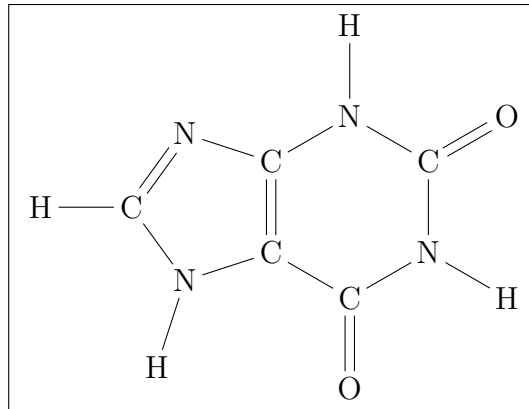

File: out/001_g_0_10300000

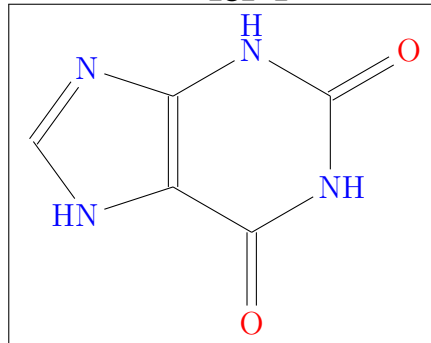

File: out/003_g_0_11310100

0.1.2 Caffeine

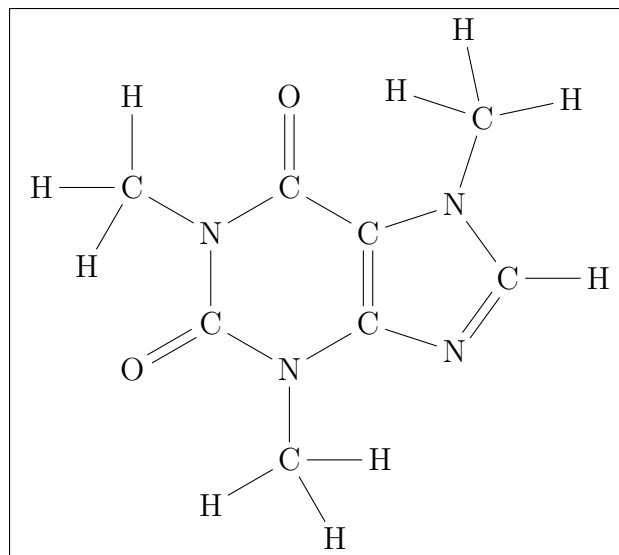

File: out/005_g_1_10300000

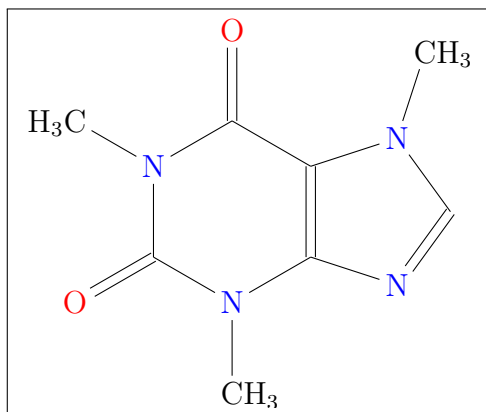

File: out/007_g_1_11310100

0.2 Loaded Rules

0.2.1 r_{0}

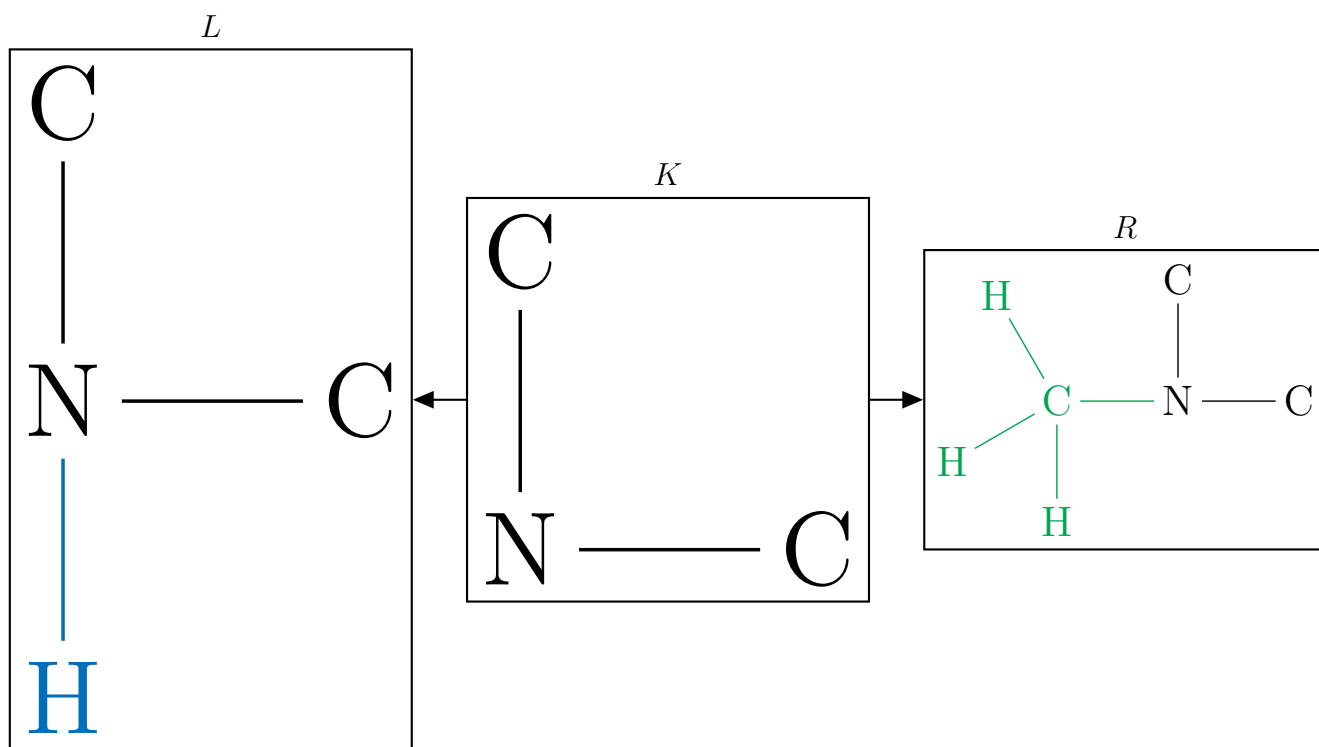

Files: out/009_r_0_10300000_{L, K, R}

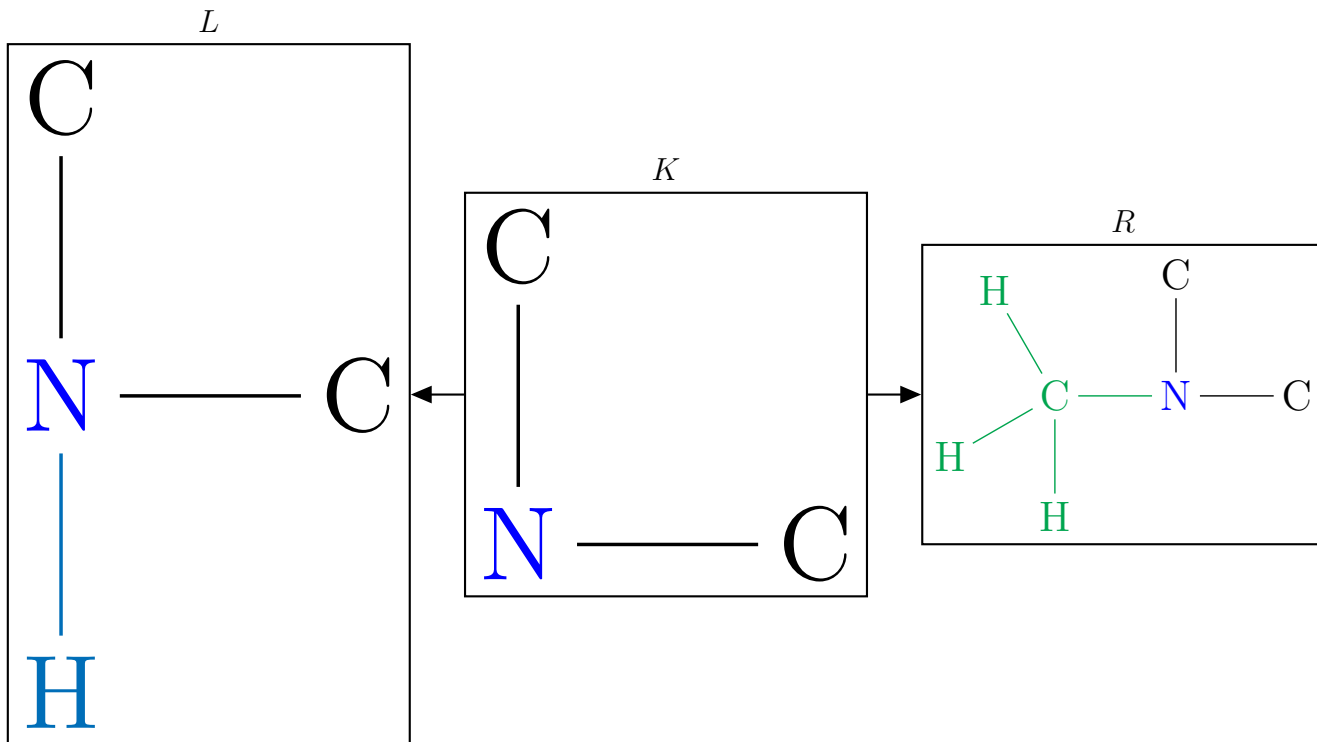

Files: out/011_r_0_11300100_{L, K, R}

0.2.2 $r_{\{1\}}$

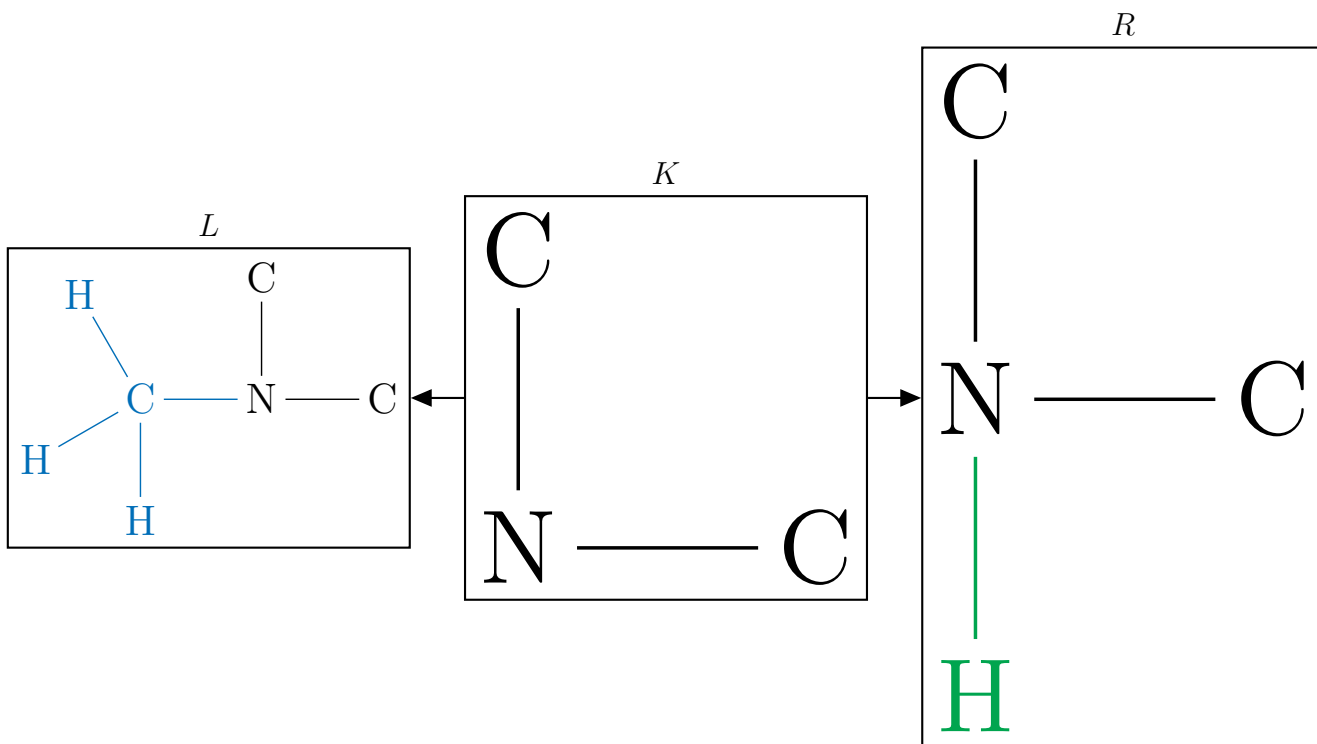

Files: out/014_r_1_10300000_{L, K, R}

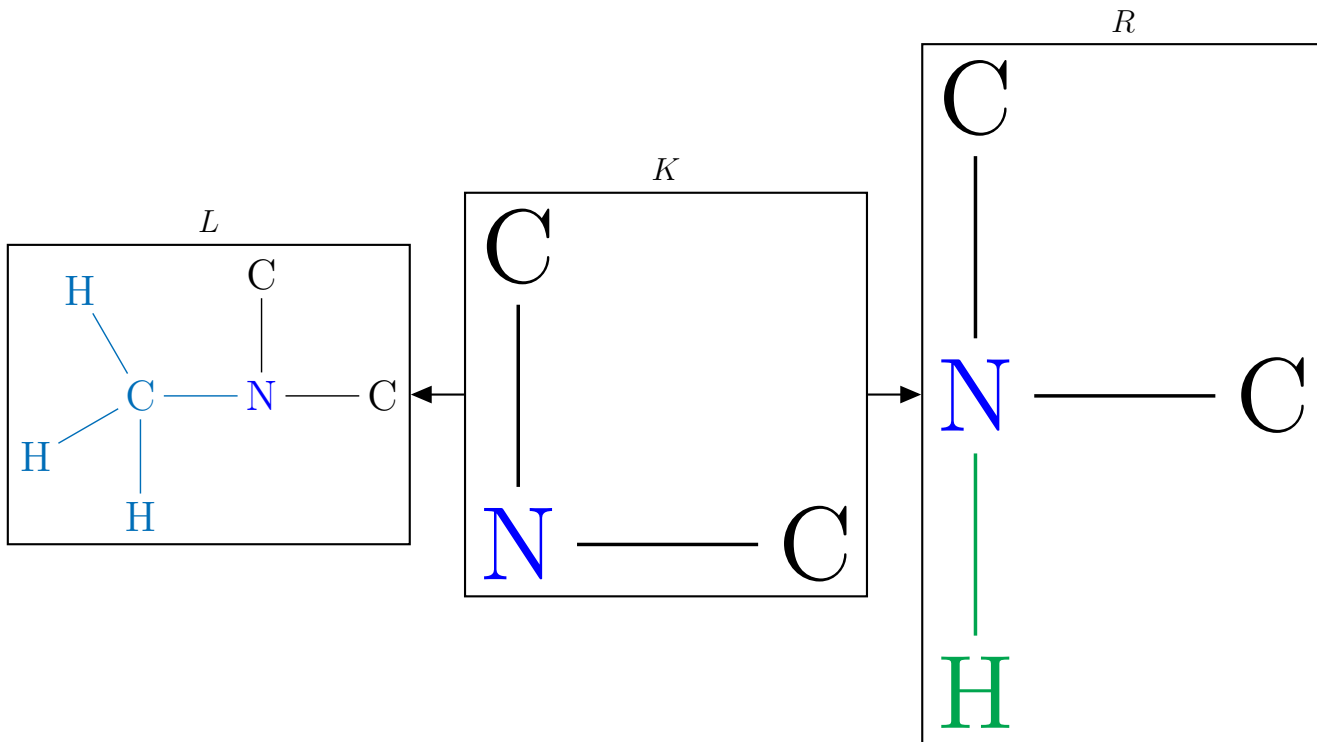

Files: out/016_r_1_11300100_{L, K, R}

0.2.3 DG Hyper, dg_0

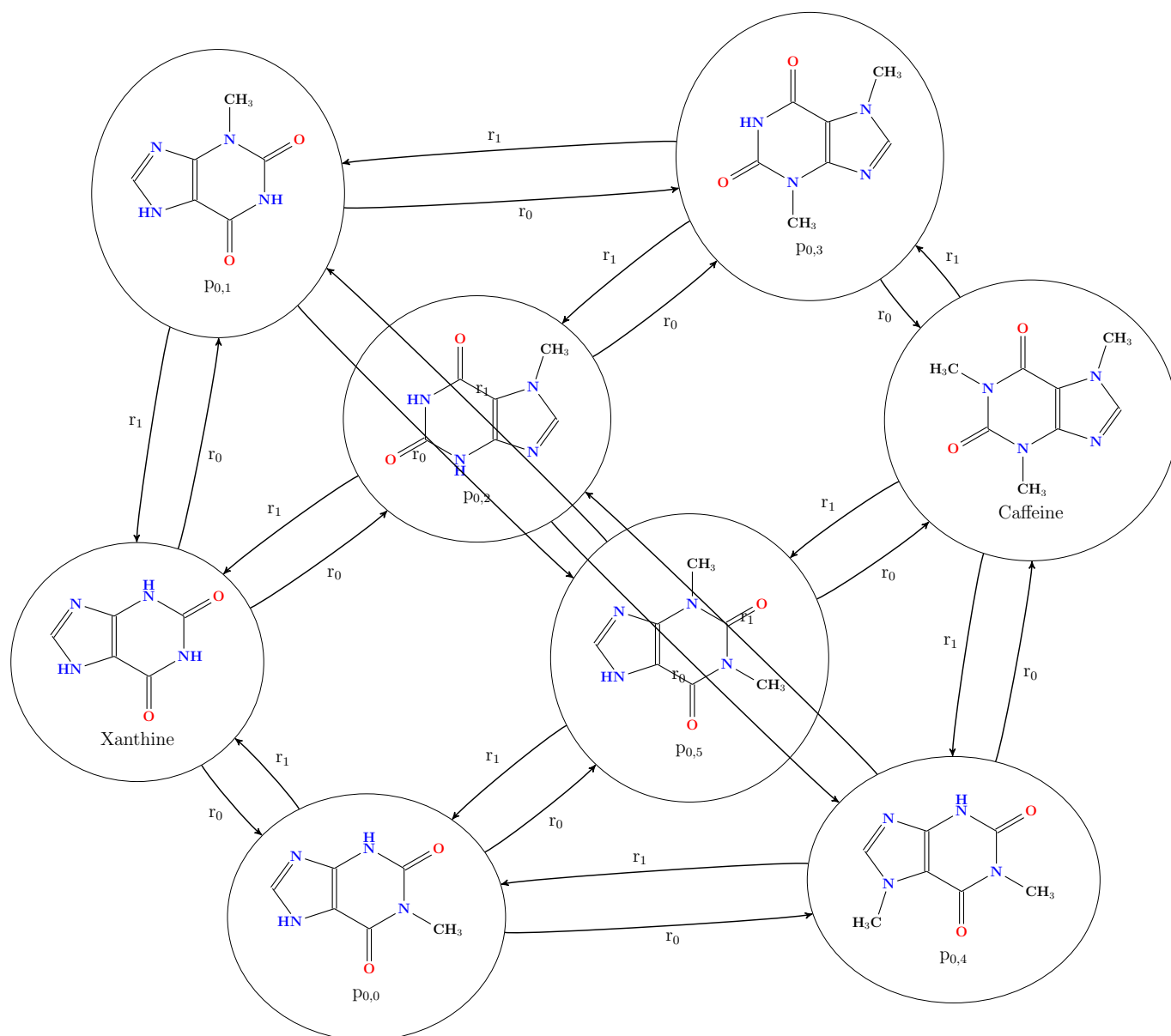

File: out/033_dg_0_11100

0.3 Product Graphs

0.3.1 Xanthine

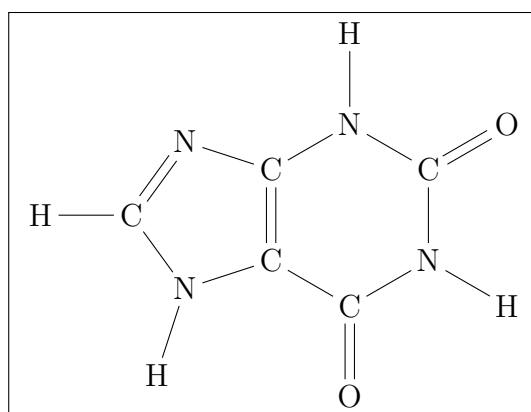

File: out/001_g_0_10300000

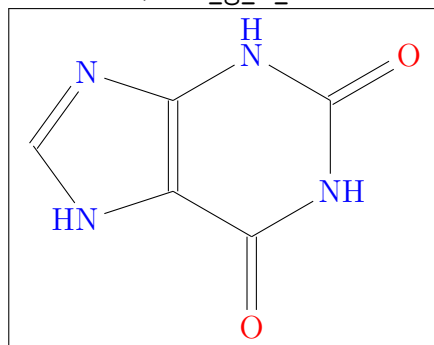

File: out/003_g_0_11310100

0.3.2 Caffeine

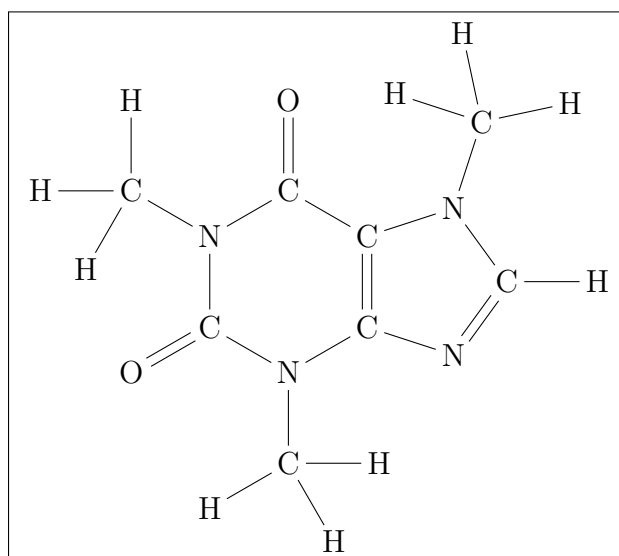

File: out/005_g_1_10300000

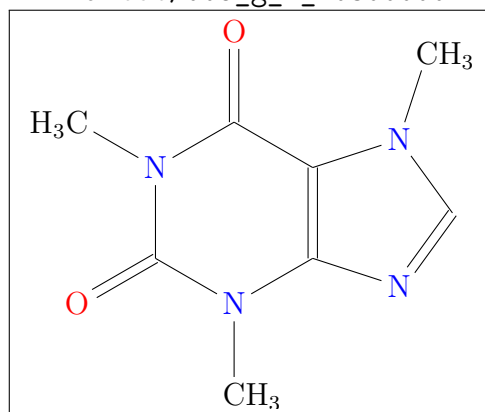

File: out/007_g_1_11310100

0.3.3 p_{0,0}

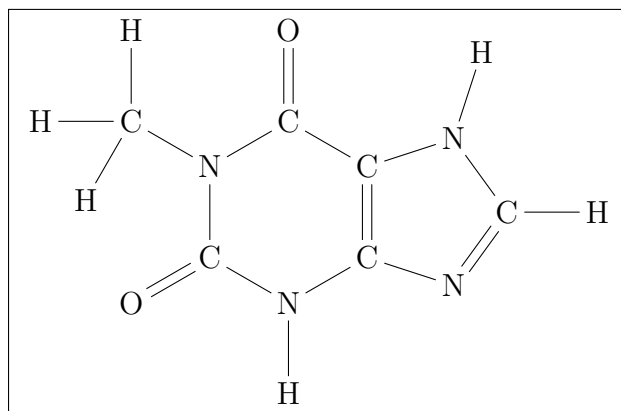

File: out/035_g_2_10300000

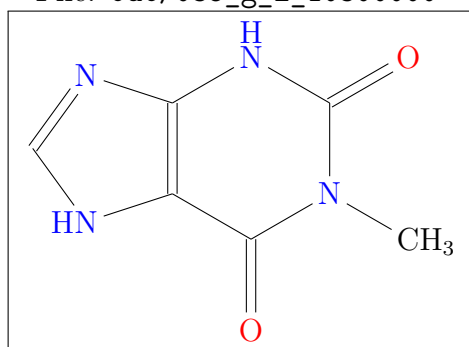

File: out/036_g_2_11310100

0.3.4 p_{0,1}

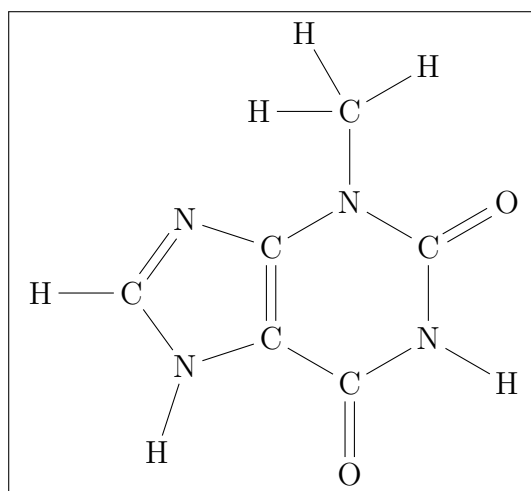

File: out/038_g_4_10300000

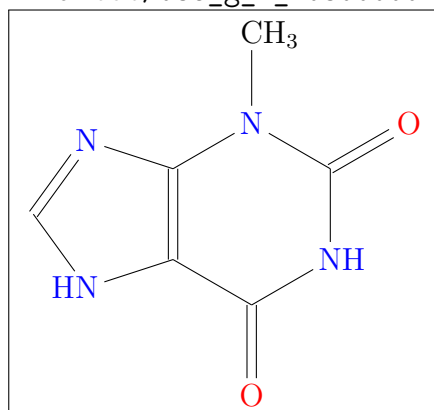

0.3.5 p_{0,2}

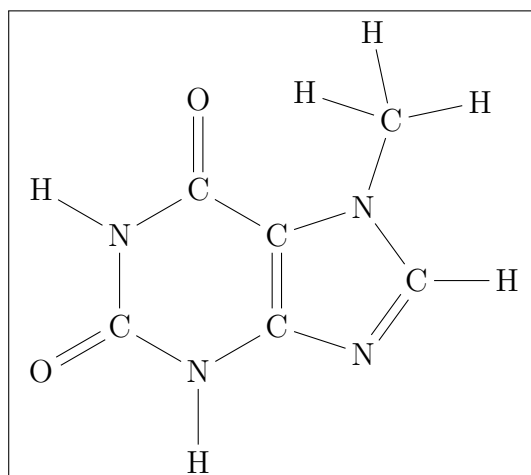

File: out/041_g_6_10300000

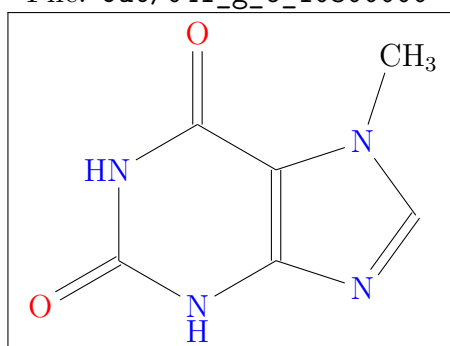

File: out/042_g_6_11310100

0.3.6 p_{0,3}

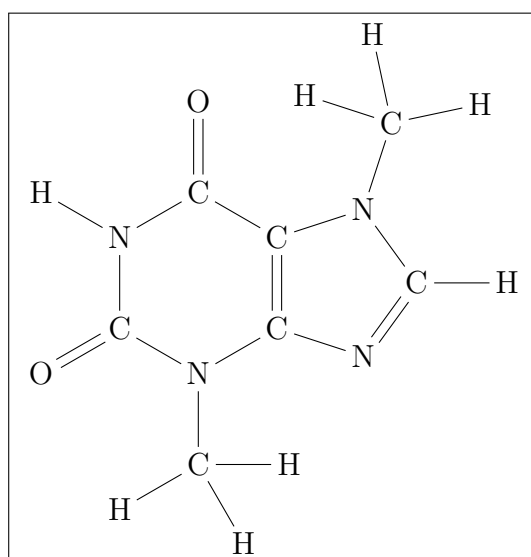

File: out/044_g_8_10300000

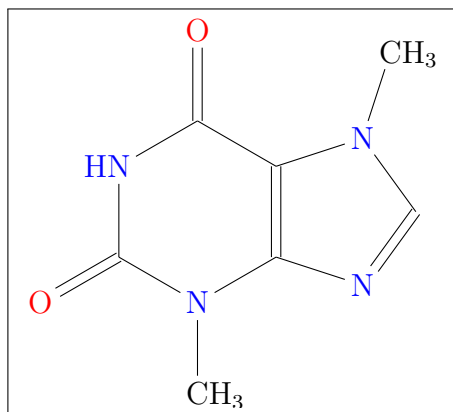

File: out/045_g_8_11310100

0.3.7 p_{0,4}

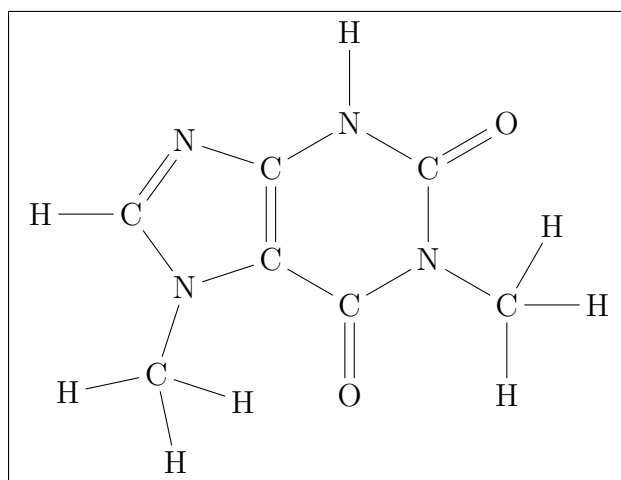

File: out/047_g_20_10300000

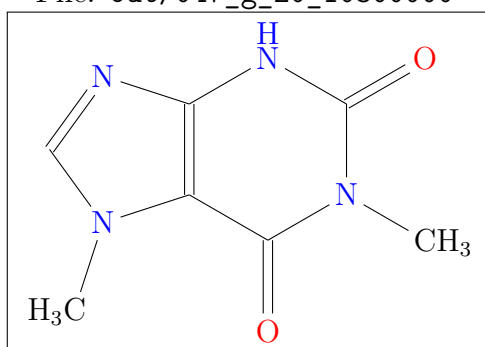

File: out/048_g_20_11310100

0.3.8 p_{0,5}

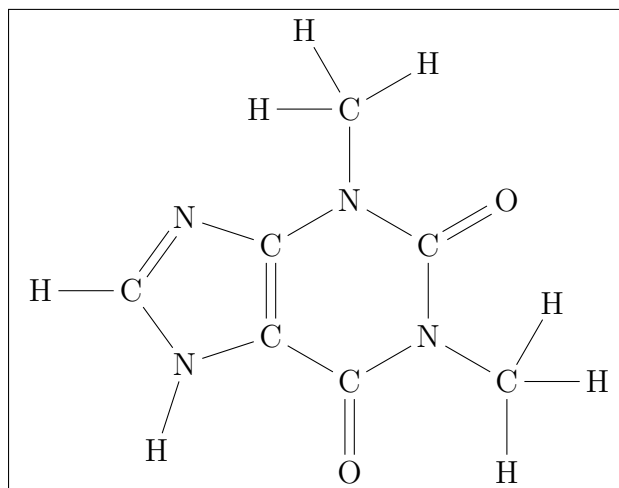

File: out/050_g_32_10300000

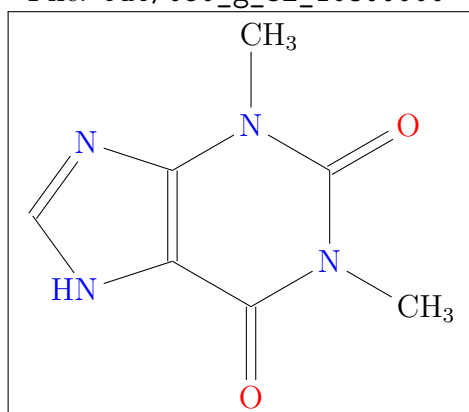

File: out/051_g_32_11310100

0.4 Hyperflow Solutions, id 0